



## SUPRA 2.0 Abdu Active-wheelchair for kids & adolescents

### Basic configuration:

- Foot rest standard
- Adjustable backrest with adjustable back cover
- Rear wheels **HOGGI** light
- **HOGGI** light sports brake
- Seat cover

Crash tested according to ISO 7176-19

### Price:

Order form incl. Exportprices (€) Release date 02/2021, valid until 31.12.2021

<input type="checkbox"/> Offer	<input type="checkbox"/> Order
Order number / reference	Date
<b>Invoice address</b>	
Company	Customer number
Street	City, Zip code
E-Mail	Telephone
Fax	
<b>Delivery address</b>	
Company	
Street	City, Zip code



### Basic configuration

- Powder coated aluminium rigid frame active wheelchair with 6 cm abduction growing seat depth
- 3 size variations:
  - Size 1: SW 24-34cm in 2cm-steps, SD 19-34 cm
  - Size 2: SW 28-38cm in 2cm-steps, SD 20-39 cm
  - Size 3: SW 28-38cm in 2cm-steps, SD 25-44 cm
- Rear wheels with hollow chamber rims and low-resistance tires incl. handrims, removable via Quick Release Axis
- Wheel camber optional 3°, 6° or 9°
- Backrest angle adjustable from 70° to 105°
- Adjustable back cover or back panel
- Seat height front: 38 cm to 51 cm
- Seat angle: 0° to 10°
- Convertible to other seat widths
- Foot rest: Standard
- Maximum load: 60 kg size 1, 75 kg size 2 and 3

### Minimum information (Without this information your order can not be handled.)

#### Frame colour

<b>Seat width</b>	in cm	<input type="checkbox"/> 24	<input type="checkbox"/> 26	<input type="checkbox"/> 28	<input type="checkbox"/> 30	<input type="checkbox"/> 32	<input type="checkbox"/> 34	<input type="checkbox"/> 36	<input type="checkbox"/> 38
<b>Camber</b>		<input type="checkbox"/> 3° (3240-1370)	<input type="checkbox"/> 6° (3240-1350)	<input type="checkbox"/> 9° (3240-1360)					

#### Presettings

<b>Seat angle</b>	0° - 10°	<b>Seat height *</b>	(38 - 51 cm)
<b>Seat depth (SD) **</b>	(19 - 44 cm)	<b>Lower Leg Length (LLL) ***</b>	(16 - 46 cm)
<b>Backrest angle</b>	<input type="checkbox"/> 70° <input type="checkbox"/> 75° <input type="checkbox"/> 80° <input type="checkbox"/> 85° <input type="checkbox"/> 90° <input type="checkbox"/> 95° <input type="checkbox"/> 100° <input type="checkbox"/> 105°	<b>Backrest height</b>	(20 - 40 cm) partly only with telescopic tubes/single push handle
		<b>Active degree (AD)</b>	

\* see table "Seat height"

\*\* Possible SD frame size 1: 19 - 34 cm; size 2: 20 - 39 cm; size 3: 25 - 44 cm, see table "Seat depth"

\*\*\* Possible LLL frame size see table „Lower leg length“

At missing specifications, we will adjust to:

SD = SW, seat angle = 4°, seat height = mid dimension, LLL = seat depth, back height = minimum, back angle = 90°, active degree = 3  
 rear wheel: **HOGGI** light with aluminium design rim, push rim mounting "standard", front wheel: wheel with rubber tire

## Basic variation

with/or: Please select only one version! SW=Seat width

	Orderno.	Colour	Description	Qty.	Price	€
	<input type="checkbox"/> 3284-00SW		<b>SUPRA 2.0 Abdu size 1, SD 17 - 34 cm</b>	<b>1 pc.</b>		
with	<input type="checkbox"/> 3284-22SW	320	Seat cover size 1	<b>01</b>	1 set	incl.
or	<input type="checkbox"/> 3281-23SW	052	Seat panel, size 1	<b>02</b>	1 set	incl.
	<input type="checkbox"/> 3285-00SW		<b>SUPRA 2.0 Abdu size 2, SD 22 - 39 cm</b>	<b>1 pc.</b>		
with	<input type="checkbox"/> 3285-22SW	320	Seat cover size 2	<b>01</b>	1 set	incl.
or	<input type="checkbox"/> 3282-23SW	052	Seat panel, size 2	<b>02</b>	1 set	incl.
	<input type="checkbox"/> 3286-00SW		<b>SUPRA 2.0 Abdu size 3, SD 28 - 45 cm</b>	<b>1 pc.</b>		
with	<input type="checkbox"/> 3286-22SW	320	Seat cover size 3	<b>01</b>	1 set	incl.
or	<input type="checkbox"/> 3283-23SW	052	Seat panel, size 3	<b>02</b>	1 set	incl.
or	<input type="checkbox"/> 3281-2299		Without seat cover		1 set	
with	<input type="checkbox"/> 3281-35SW	000	Back rest frame, back height 20 cm	<b>03</b>	1 set	incl.
with	<input type="checkbox"/> 3281-36SW	000	Back rest frame, back height 25 cm		1 set	incl.
with	<input type="checkbox"/> 3281-37SW	000	Back rest frame, back height 30 cm		1 set	incl.
with	<input type="checkbox"/> 3281-38SW	000	Back rest frame, back height 35 cm		1 set	incl.
with	<input type="checkbox"/> 3281-24SW	320	Adaptable back cover back height 20 - 25 cm	<b>04</b>	1 set	incl.
with	<input type="checkbox"/> 3281-25SW	320	Adaptable back cover back height 25 - 35 cm		1 set	incl.
with	<input type="checkbox"/> 3281-26SW	320	Adaptable back cover back height 30 - 40 cm		1 set	incl.
			<b>* Height adjustment only with 3251-2175 or 3261-5102</b>			
or	<input type="checkbox"/> 3282-52SB	000	Back panel in frame colour, back height 25 (max. SW 36)	<b>05</b>	1 set	incl.
or	<input type="checkbox"/> 3282-53SB	000	Back panel in frame colour, back height 30		1 set	incl.
or	<input type="checkbox"/> 3282-54SB	000	Back panel in frame colour, back height 35		1 set	incl.
or	<input type="checkbox"/> 3282-55SB	000	Back panel in frame colour, back height 40 (with back rest frame BH 35)		1 set	incl.
or	<input type="checkbox"/> 3281-2499		Without adaptable back cover or back panel		1 set	
with	<input type="checkbox"/> 3251-2175		Telescopic tubes for back rest height adjustment (from BH 25)	<b>06</b>	1 set	
or	<input type="checkbox"/> 3261-5102		Single push handle for back rest height adjustment (from BH 25)	<b>07</b>	1 set	
			<b>* single push handles are plugged into the back rest frame tubes</b>			
or	<input type="checkbox"/> 3281-5201		Standard single push handles 90°, size 1	<b>08</b>	1 set	
or	<input type="checkbox"/> 3281-5202		Standard single push handles 90°, size 2		1 set	
or	<input type="checkbox"/> 3275-5501		One-hand push handle (max. SW 36)	<b>09</b>	1 pc.	
or	<input type="checkbox"/> 3281-55SW		Push bar SUPRA 2.0	<b>10</b>	1 pc.	
or	<input type="checkbox"/> 3281-53SW		Push-handles SUPRA 2.0	<b>11</b>	1 set	
with	<input type="checkbox"/> 3281-3401		Back rest fixed	<b>12</b>	1 set	incl.
			Back rest frame with additional relax position (15°)			
or	<input type="checkbox"/> 3281-34SW		Retractable and lockable in transport position (upcharge)	<b>13</b>	1 set	
with	<input type="checkbox"/> 3281-7300		Tie down kit according to ISO 7176-19 * (upcharge)	<b>14</b>	1 set	
with	<input type="checkbox"/> 3274-7301		Back rest extension (only with back panel)	<b>15</b>	1 set	
with	<input type="checkbox"/> 3274-7370	306	Cushion for back rest extension, black check	<b>16</b>	1 pc.	
			<b>* If there is no shoulder and head support mounted in the handicapped transport vehicle, SUPRA 2.0 needs a back panel and back extension.</b>			
with	<input type="checkbox"/> 3284-47SW		Tube frame foot rest	<b>17</b>	1 pc.	incl.
with	<input type="checkbox"/> 3284-41SW		Footrest one piece aluminium footplate, angle adjustable	<b>18</b>	1 set	
with	<input type="checkbox"/> 3284-40SW		Footrest one piece aluminium footplate, fold backwards	<b>19</b>	1 set	
			Footrest one piece aluminium footplate, angle adjustable, for short LLL reduced by 11 cm (upcharge)	<b>20</b>	1 set	
or	<input type="checkbox"/> 3284-46SW		Footrest one piece aluminium footplate, angle adjustable, for short LLL reduced by 7 cm (upcharge)		1 set	
or	<input type="checkbox"/> 3284-48SW		Footrest one piece aluminium footplate, angle adjustable, foldable (upcharge)	<b>21</b>	1 set	
or	<input type="checkbox"/> 3284-43SW		Footrest one piece aluminium footplate, angle adjustable, foldable (upcharge)	<b>22</b>	1 pair	
or	<input type="checkbox"/> 3284-45SW		Single foot plate footrest, angle adjustable, foldable (upcharge)			

**Brakes, fender**

with/or: Please select only one version!

	Orderno.	Colour Description	Qty.	Price €
with	<input type="checkbox"/> 3281-1700	<b>HOGGI</b> light brake	<b>23</b> 1 set	incl.
or	<input type="checkbox"/> 3285-1700	Standard brakes <b>SUPRA 2.0 Abdu</b>	1 set	incl.
with	<input type="checkbox"/> 3282-160x	Side guards plane in frame colour (0=20", 2=22", 4=24") (upcharge)	1 pair	
or	<input type="checkbox"/> 3283-160x	Side guards plane in fr. colour with armrests (0=20", 2=22", 4=24") (upcharge)	<b>24</b> 1 pair	
with	<input type="checkbox"/> 7000-0051	PU-Armrest pads, 235 mm long	1 pair	incl.
or	<input type="checkbox"/> 7000-0052	PU-Armrest pads, 270 mm long	1 pair	incl.
or	<input type="checkbox"/> 3282-165y-000	Wheel guards aluminum in frame colours, 20-24" mounting: <input type="checkbox"/> fixed <input type="checkbox"/> detachable (upcharge)	<b>25</b> 1 set	
or	<input type="checkbox"/> 3282-166y-000	Wheel guards aluminum in frame colour with integrated wheel lock levers, mounting: fixed (upcharge)	<b>26</b> 1 set	
or	<input type="checkbox"/> 3282-167y-000	Wheel guards aluminum in frame colour with height adjustable, detachable arm rests, 20-24" mounting: <input type="checkbox"/> fixed <input type="checkbox"/> detachable (upcharge)	<b>27</b> 1 set	
or	<input type="checkbox"/> 3282-168y-000	Wheel guards aluminum in frame colour with integrated wheel lock levers, height adjustable, detachable arm rests, 20-24", mounting: fixed (upcharge)	<b>28</b> 1 set	
with	<input type="checkbox"/> 7000-0051	PU-Armrest pads, 235 mm long	1 pair	incl.
or	<input type="checkbox"/> 7000-0052	PU-Armrest pads, 270 mm long	1 pair	incl.
		(wheel guard y=4 narrow for 6°, 9° camber, y=5 wide for 3° camber)		
	<input type="checkbox"/> 3240-8202	Therapy tray size 2, SW 24 and 26 cm *	<b>29</b> 1 pc.	
	<input type="checkbox"/> 3240-8203	Therapy tray size 3, SW 28, 30 and 32 cm *	1 pc.	
	<input type="checkbox"/> 3240-8204	Therapy tray size 4, SW 34, 36 and 38 cm *	1 pc.	
	<input type="checkbox"/> 3240-8205	Therapy tray size 5, SW 40, 42 and 44 cm *	1 pc.	
		<b>* in combination with arm rests only</b>		

**Rear wheels**

with/or: Please select only one version!

	Orderno.	Colour Description	Qty.	Price €
with	<input type="checkbox"/> 1293-0xxx	Rear wheel <b>HOGGI</b> light	1 set	incl.
or	<input type="checkbox"/> 1293-2xxx	Rear wheel <b>HOGGI</b> light with drum brakes* (upcharge)	1 set	
		<b>*in combination with push-bar or push-handles only</b>		
with	<input type="checkbox"/> 1293-x2xx	20" wheel diameter	1 set	incl.
or	<input type="checkbox"/> 1293-x3xx	22" wheel diameter	1 set	incl.
or	<input type="checkbox"/> 1293-x4xx	24" wheel diameter	1 set	incl.
with	<input type="checkbox"/> 1293-xx1x	Pneumatic tires 1"	<b>30</b> 1 set	incl.
or	<input type="checkbox"/> 1293-xx2x	Flat free tires (20x1 3/8", 22x1" and 24x1")	<b>31</b> 1 set	incl.
with	<input type="checkbox"/> 1293-xxx0	Without push-rims		
or	<input type="checkbox"/> 1293-xxx1	Push rims aluminium anodised, "standard" mounting	<b>32</b> 1 set	incl.
or	<input type="checkbox"/> 1293-xxx2	Push rims aluminium anodised, "high" mounting	<b>33</b> 1 set	incl.
or	<input type="checkbox"/> 1293-xxx3	Push rims stainless steel, "standard" mounting (upcharge)	<b>34</b> 1 set	
or	<input type="checkbox"/> 1293-xxx4	Push rims stainless steel, "high" mounting (upcharge)	1 set	
with		<input type="checkbox"/> Push-rim mounting "narrow"		
or		<input type="checkbox"/> Push-rim mounting "wide"		
or	<input type="checkbox"/> 1296-4211	Pneumatic wheel 20x1" <b>HOGGI</b> Extra light * (upcharge)	<b>35</b> 1 set	
or	<input type="checkbox"/> 1296-4311	Pneumatic wheel 22x1" <b>HOGGI</b> Extra light * (upcharge)	1 set	
or	<input type="checkbox"/> 1296-4411	Pneumatic wheel 24x1" <b>HOGGI</b> Extra light * (upcharge)	1 set	
		<b>* incl. black alu push-rim</b>		

**Spoke guards**

	Orderno.	Colour Description	Qty.	Price €
	<input type="checkbox"/> 1204-101x	Spoke guard, transparent	<b>36</b> 1 set	
	<input type="checkbox"/> 1204-101x	Spoke guard, transparent, for drum brakes wheels	1 set	
	<input type="checkbox"/> 1204-101x	Spoke guard, printed *	<b>37</b> 1 set	
	<input type="checkbox"/> 1204-101x	Spoke guard, printed for drum brakes*	1 set	
		<b>* please enter code of your print design see attachment or brochure "spoke guard"</b>		
		<b>* printed spoke guards are not available for 20" wheels</b>		

**Front castors**

with/or: Please select only one version!

	Orderno.	Colour Description	Qty.	Price €
with <input type="checkbox"/>	1250-1002	Wheel with rubber tire, black 100 x 32 mm	<b>38</b> 1 set	incl.
or <input type="checkbox"/>	1250-1003	Wheel with rubber tire, black 125 x 32 mm	1 set	incl.
or <input type="checkbox"/>	1250-1005	Wheel with rubber tire, black 140 x 40 mm	1 set	incl.
or <input type="checkbox"/>	1249-1005	Skater wheel with LED 100 x 24 mm (upcharge)	<b>39</b> 1 set	
or <input type="checkbox"/>	1249-1006	Skater wheel with LED 125 x 24 mm (upcharge)	1 set	
or <input type="checkbox"/>	1221-1003	PU-wheel with plastic design rim 100 x 34 mm (upcharge)	<b>40</b> 1 set	
or <input type="checkbox"/>	1221-1004	PU-wheel with plastic design rim 125 x 34 mm (upcharge)	1 set	
or <input type="checkbox"/>	1221-1001	PU-wheel with aluminium design rim 100x32 (upcharge)	1 set	
or <input type="checkbox"/>	1221-1002	PU-wheel with aluminium design rim 125x32 (upcharge)	1 set	

**Accessories**

SW=Seat width

	Orderno.	Colour Description	Qty.	Price €
<input type="checkbox"/>	3281-880x	Calf strap <b>SUPRA 2.0</b> with upholstery, black	<b>41</b> 1 set	
<input type="checkbox"/>	3281-1901	<b>SUPRA 2.0</b> Anti tip 20", swing away, left	<b>42</b> 1 pc.	
<input type="checkbox"/>	3281-1902	<b>SUPRA 2.0</b> Anti tip 20", swing away, right	1 pc.	
<input type="checkbox"/>	3282-1901	<b>SUPRA 2.0</b> Anti tip 22 + 24", swing away, left	1 pc.	
<input type="checkbox"/>	3282-1902	<b>SUPRA 2.0</b> Anti tip 22 + 24", swing away, right	1 pc.	
<input type="checkbox"/>	3281-190x	Tip assist, left <input type="checkbox"/> =3 or right <input type="checkbox"/> =4	<b>43</b> 1 pc.	
<input type="checkbox"/>	3251-71SW	322 Seat cushion; 3 cm thick, size 1	<b>44</b> 1 pc.	
<input type="checkbox"/>	3252-71SW	322 Seat cushion; 3 cm thick, size 2	1 pc.	
<input type="checkbox"/>	3253-71SW	322 Seat cushion; 3 cm thick, size 3	1 pc.	
<input type="checkbox"/>	3276-7100	306 Back cushion for back panle, 2,5 cm thick (SB und RH)	<b>45</b> 1 pc.	
<input type="checkbox"/>	3201-3830	Universal headrest bracket (for 3245-7800 or third-party products) *	<b>46</b> 1 pc.	
<input type="checkbox"/>	3245-7800	306 Headrest with occiput upholstery	<b>47</b> 1 pc.	
		<b>* starting from backrest height 30 cm</b>		
<input type="checkbox"/>	3251-77SW	Nylon back cover to cover the back upholstery belts	<b>48</b> 1 pc.	
<input type="checkbox"/>	3251-7600	Edge protector for back rest tubes and telescopic tubes	<b>49</b> 1 set	
<input type="checkbox"/>	1204-101x	Push-rim cover, silicone black fluted	<b>50</b> 1 set	
<input type="checkbox"/>	3281-6100	Lap belt	<b>51</b> 1 pc.	
<input type="checkbox"/>	3201-6400	Ankle hugger, size 1	<b>52</b> 1 pair	
<input type="checkbox"/>	3203-6400	Ankle hugger, size 2	1 pair	
<input type="checkbox"/>	3220-6702	4-Point lap belt, size S (SW 24 - 30)	<b>53</b> 1 pc.	
<input type="checkbox"/>	3220-6703	4-Point lap belt, size M (SW 28 - 36)	1 pc.	
<input type="checkbox"/>	3220-6704	4-Point lap belt, size L (SW 34 - 42)	1 pc.	
<input type="checkbox"/>	3231-7800	323 Abduction block size 1, swing away, detachable, (9 x 6 x 9 cm) *	<b>54</b> 1 set	
<input type="checkbox"/>	3231-7900	323 Abduction block size 2 swing away, detachable, (11 x 8 x 10 cm) *	1 set	
<input type="checkbox"/>	3233-7800	323 Abduction block size 3 swing away, detachable, (12 x 9 x 10 cm) *	1 set	
		<b>* only with seat panel 328X-23SW</b>		

**Custom-made**

SW=Seat width

	Orderno.	Colour	Description	Qty.	Price	€
<input type="checkbox"/>	3281-80SW	322	Contoured seat cushion with cover, black, SW 24 - 32	<b>55</b>	1 pc.	
<input type="checkbox"/>	3281-80SW	322	Contoured seat cushion with cover, black, SW 34 - 44		1 pc.	
<input type="checkbox"/>	SA-0286/2-KP		Abduction block 30 mm height extension kit *		1 set	
<b>* only in combination with abduction block and contoured seat cushion</b>						
<input type="checkbox"/>	6999-0014	060	Special Frame colour, Copper Gold	<b>(Upcharge)</b>	1 pc.	
<input type="checkbox"/>	6999-0021/1		Castor forks powder coated according to customer requirements * (no glitter)	<b>(upcharge)</b>	1 set	
<input type="checkbox"/>	6999-0021/2		Back retainer plates powder coated, color according to customer specification	<b>(upcharge)</b>	1 set	
<input type="checkbox"/>	6999-0021/3		Alu-wheel guards powder coated, color according to customer specification	<b>(upcharge)</b>	1 set	
<input type="checkbox"/>	SA-0390		Upholstery in special colour *		Price on request	
<b>* please enter colour code or upholstery code respectively</b>						
<input type="checkbox"/>	SA-0572-XXS-MP		Aluminum hand rim with plastic anti-slip coating, black, standard mounting *	<b>(Upcharge)</b>	<b>56</b>	1 pair
<input type="checkbox"/>	SA-0572-XXH-MP		Aluminum hand rim with plastic anti-slip coating, black, high mounting *	<b>(Upcharge)</b>		1 pair
<input type="checkbox"/>	SA-0572-F-MP		Plastic anti-slip coating in custom colour: Pure white (RAL 9010), Silver grey (RAL 7001), Sky blue (RAL 5015), Traffic red (RAL 3020), Pure orange (RAL 2004)*	<b>(Upcharge)</b>	<b>57</b>	1 pair
<b>* only in combination with HOGGI light rear wheels</b>						
<input type="checkbox"/>	SA-008x-MP		GOLZ Rehavolution wheels with integrated push rims		<b>58</b>	Price on request
<input type="checkbox"/>	SA-0093-MP		Maxgrepp Original cell rubber coated push rims	<b>(upcharge)</b>	<b>59</b>	1 set
<input type="checkbox"/>	SA-0094-MP		Maxgrepp Ergo Para (closed push rims)	<b>(upcharge)</b>	<b>60</b>	1 set
<input type="checkbox"/>	SA-0095-MP		Maxgrepp Ergo Para CP (advanced closed push rims)	<b>(upcharge)</b>	<b>61</b>	1 set
<input type="checkbox"/>	SA-0210		Special Frame colour, RAL code only	<b>(upcharge)</b>		1 pc.
<input type="checkbox"/>	SA-0500-MP		Additional coating "silver glitter effect"	<b>(upcharge)</b>		1 pc.

Seat height front

SUPRA 2.0 Seat height front																			
Frame size	Seat angle	short front fork, castors pos. 1281-1023									long front fork, castors pos. 1281-1026								
		100			125			140			100			125			140		
		1	2	3	1	2	3	1	2	3	2	3	4	2	3	4	2	3	4
1	0°	38	39	41	39	41	42	40	41	43	41	42	43	42	43	44	43	44	45
	4°	38	39	40	39	40	41	40	41	42	40	41	43	41	43	44	42	43	45
	7°	37	38	39	38	39	41	39	40	41	39	41	42	41	42	43	41	43	44
	10°	36	37	39	37	39	40	38	39	41	39	40	41	40	41	42	41	42	43
2	0°	40	41	43	41	43	44	42	43	45	43	44	45	44	45	46	45	46	47
	4°	40	41	42	41	42	43	42	43	44	42	43	45	43	45	46	44	45	47
	7°	39	40	41	40	41	43	41	42	43	41	43	44	43	44	45	43	45	46
	10°	38	39	41	39	41	42	40	41	43	41	42	43	42	43	44	43	44	45
3	0°	45	46	48	46	48	49	47	48	50	48	49	50	49	50	51	50	51	52
	4°	44	46	47	46	47	48	46	48	49	47	48	49	48	49	51	49	50	51
	7°	44	45	46	45	46	47	46	47	48	46	47	49	47	49	50	48	49	51
	10°	43	44	45	44	45	47	45	46	47	45	47	48	47	48	49	47	49	50

(Measured at front edge of seat cover ± 0,5 cm)

Lower Leg Length

SUPRA 2.0 Abdu / SUPRA 2.0 Seat height and Lower Leg Length according to frame size								
size	SH (at 4° Seat angle)	Footrests						
		3294-47SB 3281-47SB Tube frame footrest	3294-41SB 3281-41SB Footrest one piece aluminium footplate, angle adjustable	3294-46SB 3281-46SB Footrest one piece aluminium footplate, angle adjustable for short LLL reduced by 11 cm	3294-48SB 3281-48SB Footrest one piece aluminium footplate, angle adjustable for short LLL reduced by 7 cm	3294-43SB 3281-43SB Footrest one piece aluminium footplate, angle adjustable, foldable	3294-45SB 3281-45SB Single foot plate footrest, angle adjustable, foldable	3294-40SB 3281-40SB Footrest one piece aluminium footplate, fold backwards
SUPRA 2.0 Frame size 1	38	28 - 34	28 - 34	16 - 23	20 - 26	28 - 34	28 - 34	28 - 35
	39	28 - 35	28 - 35	16 - 24	20 - 27	28 - 35	28 - 35	28 - 36
	40	28 - 36	28 - 36	16 - 25	20 - 28	28 - 36	28 - 36	28 - 37
	41	28 - 37	28 - 37	16 - 26	20 - 29	28 - 37	28 - 37	28 - 38
	42	28 - 38	28 - 38	16 - 27	20 - 30	28 - 38	28 - 38	28 - 39
	43	28 - 39	28 - 39	16 - 28	20 - 31	28 - 39	28 - 39	28 - 40
	44	28 - 40	28 - 40	16 - 29	20 - 32	28 - 40	28 - 40	28 - 41
SUPRA 2.0 Frame size 2	45	28 - 40	28 - 40	16 - 29	20 - 32	28 - 40	28 - 40	28 - 41
	40	30 - 34	30 - 34	19 - 24	23 - 27	30 - 34	30 - 34	30 - 35
	41	30 - 35	30 - 35	19 - 25	23 - 28	30 - 35	30 - 35	30 - 36
	42	30 - 36	30 - 36	19 - 26	23 - 29	30 - 36	30 - 36	30 - 37
	43	30 - 37	30 - 37	19 - 27	23 - 30	30 - 37	30 - 37	30 - 38
	44	30 - 38	30 - 38	19 - 28	23 - 31	30 - 38	30 - 38	30 - 39
	45	30 - 39	30 - 39	19 - 29	23 - 32	30 - 39	30 - 39	30 - 40
SUPRA 2.0 Frame size 3	46	30 - 40	30 - 40	19 - 30	23 - 33	30 - 40	30 - 40	30 - 41
	47	30 - 41	30 - 41	19 - 31	23 - 34	30 - 41	30 - 41	30 - 42
	44	34 - 40	34 - 40	23 - 28	27 - 32	34 - 40	34 - 40	34 - 41
	45	34 - 41	34 - 41	23 - 29	27 - 33	34 - 41	34 - 41	34 - 42
	46	34 - 42	34 - 42	23 - 30	27 - 34	34 - 42	34 - 42	34 - 43
	47	34 - 43	34 - 43	23 - 31	27 - 35	34 - 43	34 - 43	34 - 44
	48	34 - 44	34 - 44	23 - 32	27 - 36	34 - 44	34 - 44	34 - 45
49	34 - 45	34 - 45	23 - 33	27 - 37	34 - 45	34 - 45	34 - 46	
50	34 - 46	34 - 46	23 - 34	27 - 38	34 - 46	34 - 46	34 - 47	
51	34 - 46	34 - 46	23 - 35	27 - 39	34 - 46	34 - 46	34 - 47	

Seat depth range according to active degree

SUPRA 2.0 Seat depth range													
Wheel size 20"				Wheel size 22"						Wheel size 24"			
AD	Frame size			AD	Frame size			AD	Frame size				
	Gr.1	Gr.2	Gr.3		Gr.1	Gr.2	Gr.3		Gr.2	Gr.3			
0	19-34		20-39	0	21-34		20-39		25-44	0	23-39		25-44
1	20-34		21-39	1	22-34		21-39		26-44	1	24-39		26-44
2	21-34		22-39	2	23-34		22-39		27-44	2	25-39		27-44
3	22-34		23-39	3	24-34		23-39		28-44	3	26-39		28-44
4	23-34		24-39	4	25-34		24-39		29-44	4	27-39		29-44
5	24-34		25-39	5	26-34		25-39		30-44	5	28-39		30-44
6	25-34		26-39	6	27-34		26-39		31-44	6	29-39		31-44
7	26-34		27-39	7	28-34		27-39		32-44	7	30-39		32-44
8	27-34		28-39	8	29-34		28-39		33-44	8	31-39		33-44
9	28-34		29-39	9	30-34		29-39		34-44	9	32-39		34-44
10	29-34		30-39	10	31-34		30-39		35-44	10	33-39		35-44

**How to measure and active degree**

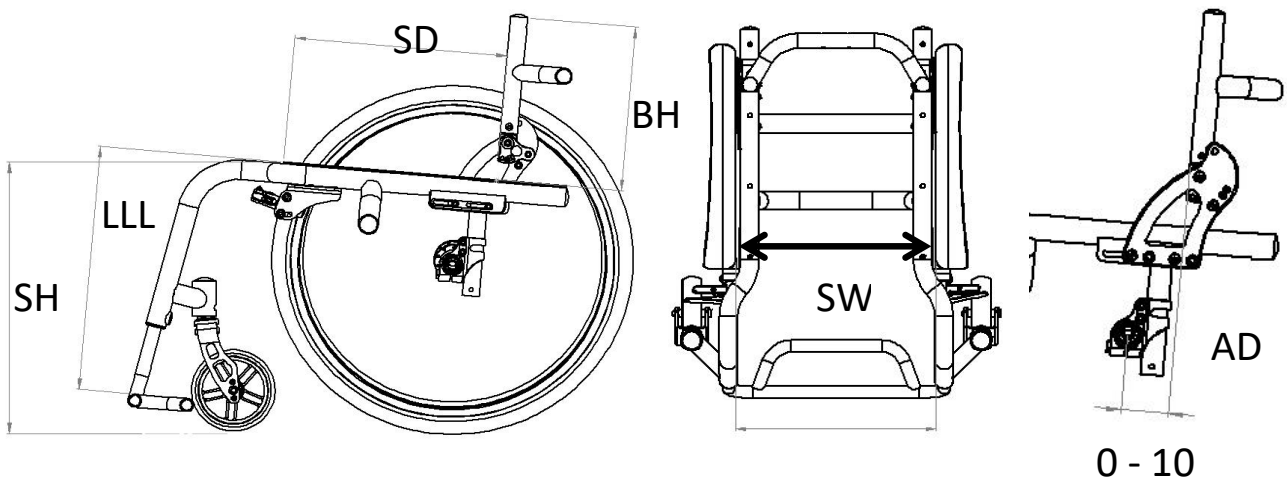

**SH** = Seat height **LLL** = Lower leg length **SD** = Seat depth **BH** = Back height **SW** = Seat width **AD** = Active degree  
 (All measurements are without seat or back upholstery)

**Frame colours**

<b>001</b> Black (RAL 9005)	<b>020</b> Yellow green (RAL 6018)	<b>028</b> Pearl violet (RAL 4011)	<b>053</b> Light green (RAL 6027)
<b>002</b> Silver	<b>021</b> Greyaluminium (RAL 9007)	<b>029</b> Pearl beige (RAL 1035)	<b>054</b> Ocean blue (RAL 5020)
<b>003</b> Pearl ruby red (RAL 3032)	<b>022</b> White (RAL 9003)	<b>032</b> Black dull matt (RAL 9005)	<b>056</b> Turquoise blue (RAL 5018)
<b>004</b> Pearl night blue (RAL 5026)	<b>023</b> Pure orange (RAL 2004)	<b>039</b> Signal violet (RAL 4008)	<b>057</b> Iron sparkling dark light
<b>005</b> Pearl gentiant blue (RAL 5025)	<b>024</b> Sparkling iron effect	<b>040</b> Night blue (RAL 5022)	<b>058</b> Salmon orange (RAL 2012)
<b>017</b> Traffic yellow (RAL 1023)	<b>025</b> Signal blue (RAL 5005)	<b>047</b> Luminous yellow (RAL 1026)	<b>059</b> Pastel blue (RAL 5024)
<b>018</b> Flame red (RAL 3000)	<b>026</b> Vermillion (RAL 2002)	<b>048</b> Luminous red (RAL 3024)	
<b>019</b> Skyblue (RAL 5015)	<b>027</b> Heather violet (RAL 4003)	<b>050</b> White matt (RAL 9003)	

**SA-0500-MP** additional coating "silver glitter effect", **Upcharge**  
**SA-0210-MP** Special colours on request (Enter RAL code , **Upcharge**

**Spoke guard print design (for detailed images see attachment or brochure "spoke guard")**

**Colour code**

<b>201</b>	<b>HOGGI</b> blue
<b>202</b>	Wonderland
<b>203</b>	Mouse
<b>204</b>	Water world
<b>205</b>	Train
<b>206</b>	Dragon
<b>207</b>	Circus



# CONFIGURATIONS // ACCESSORIES // SUPRA 2.0 Abdu



01 Seat cover



02 Seat panel



03 Back rest frame



04 Adaptable back cover

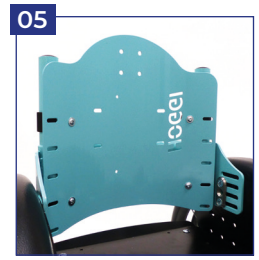

05 Back panel



06 Telescopic tubes



07 Single push handle



08 Single push handles 90°



09 One-hand push handle



10 Push bar



11 Push-handles



12 Back rest fixed



13 Back rest, retractable



14 Tie down kit

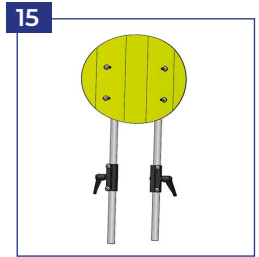

15 Back rest extension

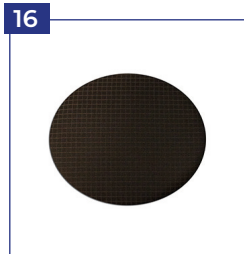

16 Cushion for back rest extension



17 Tube frame footrest



18 Footrest one piece, angle adjustable



19 Footrest one piece, fold backwards



20 Footrest, for short LLL



21 Footrest, foldable



22 Single foot plate footrest



23 HOGGI light brake



24 Side guards plane with armrests

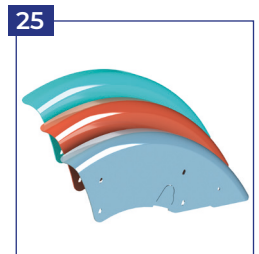

25 Wheel guards aluminum



26 Wheel guards with wheel lock levers



27 Wheel guards, height adjustable, detachable



28 Wheel guards, arm rests, wheel lock levers

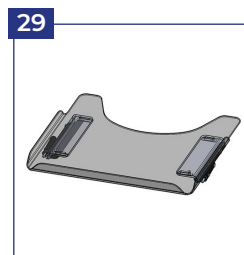

29 Therapy tray



30 Pneumatic tires



# CONFIGURATIONS // ACCESSORIES // SUPRA 2.0 Abdu



30 Pneumatic tires with drum brakes



31 Flat free tires



32 Flat free tires with drum brakes



33 Push rims, standard



34 Push rims, high



34 Push rims stainless steel, standard



35 HOGGI Extra light



36 Spoke guard, transparent



37 Spoke guard, printed



38 Wheel with rubber tire



39 Skater wheel



40 PU-wheel with plastic design rim



41 Calf strap



42 Anti tip



43 Tip assist

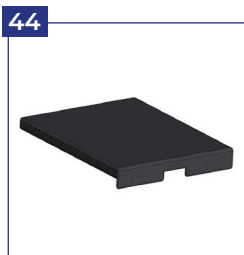

44 Seat cushion



45 Back cushion



46 Universal headrest bracket



47 Headrest with occiput upholstery



48 Nylon back cover



49 Edge protector



50 Push-rim cover



51 Lap belt



52 Ankle hugger



53 4-Point lap belt



54 Abduction block



55 Contoured seat cushion with cover



56 Aluminum hand rim with plastic anti-slip coating



57 Aluminum hand rim with plastic anti-slip coating



58 GOLZ Revolution wheels

## CONFIGURATIONS // ACCESSORIES // SUPRA 2.0 Abdu



Maxgrepp Original  
push rims



Maxgrepp Ergo Para  
push rims



Maxgrepp Ergo Para  
CP push rims